

Article number: 021816011280

Description: Clamp with bracket and rubber
SPGU 6011. 280/30 SK

Measures

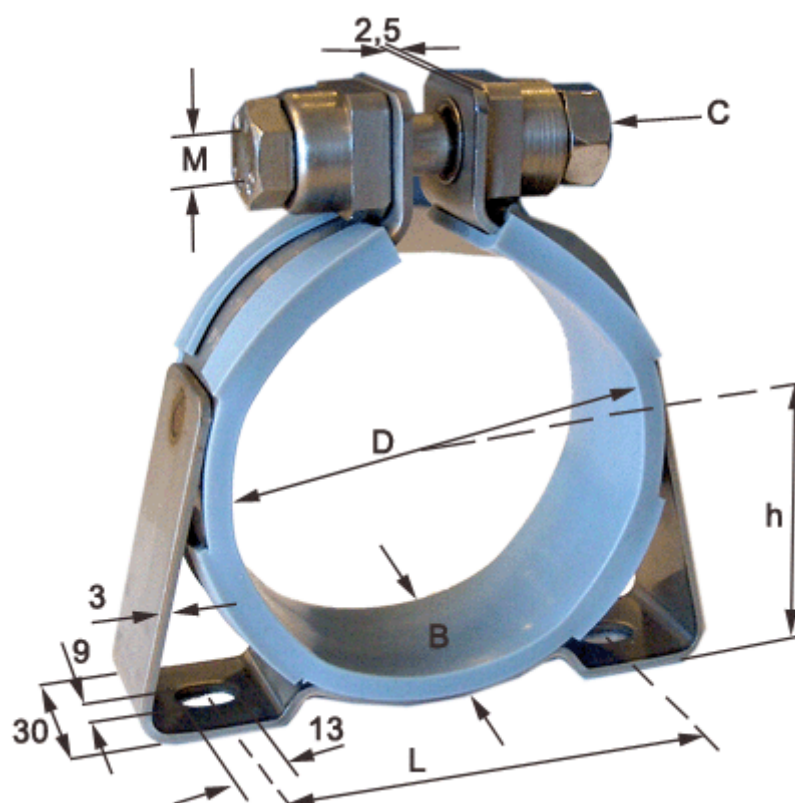

C (screw type) = SK hexagon screw

Diameter D = 280

h = 148

L = 248

Width B = 30